

VG80

Directional Control Valves

Flow to 120 gpm • 100 igpm • 450 lpm

Rated for 3500 psi • 240 bar

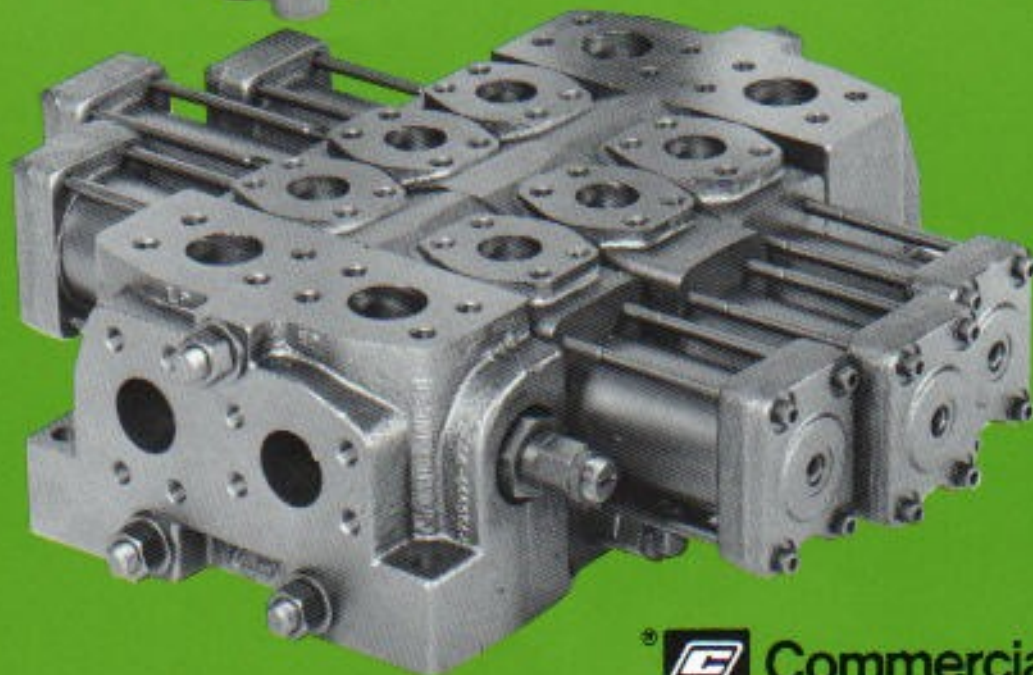

 Commercial Intertech

VG80 Directional Control Valves

Commercial's VG80 sectional type, directional control valves, the largest in our line, are rated for operating pressure up to 3500 psi/240 bar with flows up to 120 gpm/455 lpm/100 igpm. The VG80 valve is very similar in design to our VA/VG20 and 35 valves which have proven themselves over the years to offer excellent performance and reliable service. **To meet the increasing demand for performance, we have put particular emphasis on maximizing the VG80's metering capability to give the operator better control, to improve efficiency and reduce fatigue.**

INLET / OUTLETS

The combination inlet/outlet casting has a high and a low pressure port on both the top and side faces. The system relief valve is pilot operated and is screw adjustable.

Mid-section inlets are offered as a split flow type which separates the flow of more than one pump, a combined flow type which combines the flow of one or more pumps, and a two-position selector type which can be shifted to provide split flow in one position and combined flow in the other. In the combined flow mode, flow from the second pump is directed to all working sections to give 2-speed operation. This feature requires an external line from the selector section to the inlet.

Outlet covers can have high and low pressure ports on both the top and side. Internal coring allows a standard low pressure outlet to be converted to a pressure beyond type by simply replacing a short plug with a longer one. Outlet covers can also contain a relief valve.

WORKING SECTIONS

All work sections are 3" wide which allows us to use porting up to 1 1/4" split flange or SAE-24. Relief valves with anti-cavitation check and anti-cavitation checks are available for the work sections.

All work sections have parallel circuitry except for a 4th-position float section which has tandem circuitry. The float section is available only with a

Electrically detented
Joystick Controller



Electrically detented
Single-axis Controller



VG80 Valve Bank with
Remote Spool Operators

hydraulic remote spool operator. Spool actuators offered with the parallel sections include:

- Manual with spring return to neutral
- Manual with 3-position detent
- Hydraulic remote metering control
- Pilot operated control (on-off)

For optimum performance match our hydraulic remote work sections with our remote controllers.

Metric Conversion Factors

- 1 US gallon = .833 Imperial gallons
- 1 US gallon = 3.785 Liters
- 1 Inch = 25.4 Millimeters
- 1 PSI = .069 bar
- $(F^{\circ} - 32) \times .55 = C^{\circ}$
- 1 Inch pound = .113 Newton meters
- 1 Pound = .45 Kilograms



Commercial Intertech

Dimensional Data

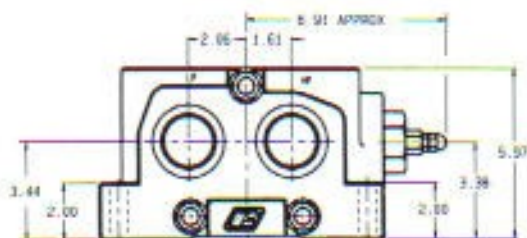
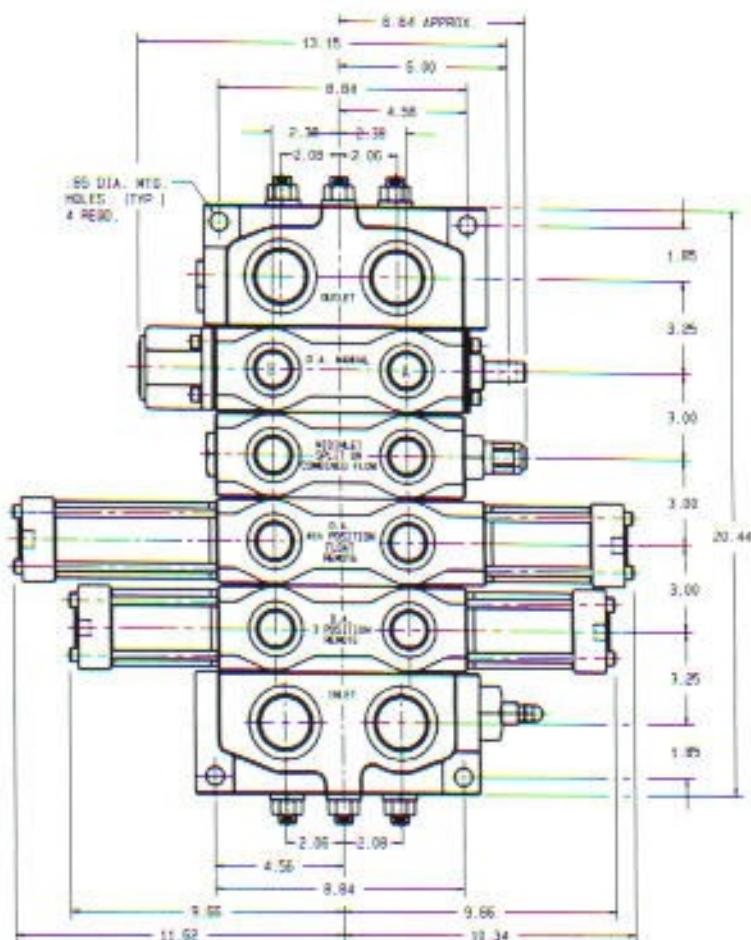
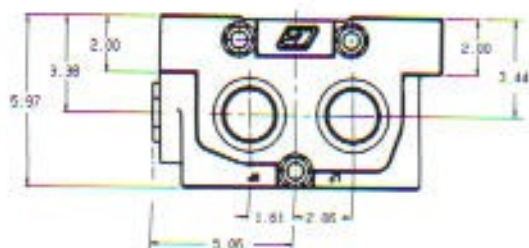

Seal Kit Part Numbers

- For Inlets & Midinlets... kit 391-1803-484
- For Work Sections... Use kit # 391-1803-594
Kit includes spool seals, section seals and transition check seals.
- For Main R/V shipped after 6/94...
Use kit # 391-1823-101
- For Main R/V shipped before 6/94...
Use kit # 391-1803-268
- For Port R/V-A/C... Use kit # 391-1803-737
- For Port A/C ... Use kit # 391-1823-038

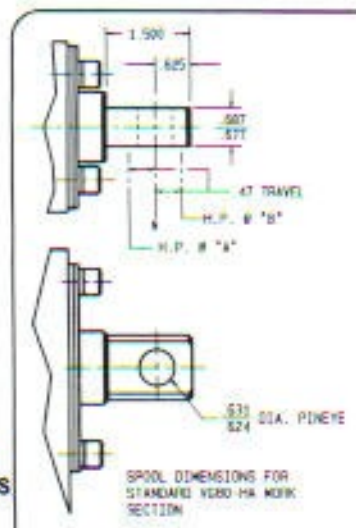
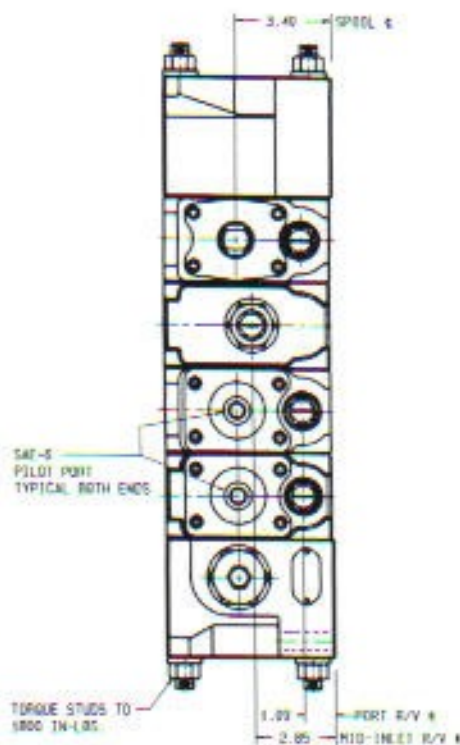

Approximate Weights (lbs)

Inlet Section.....	44.5
Work Section (Manual).....	32.5
Work Section (Remote).....	42
Work Section (Float).....	47.5
Outlet Section.....	44.5

**Torque Studs To
1800 Inch Pounds**

How To Order

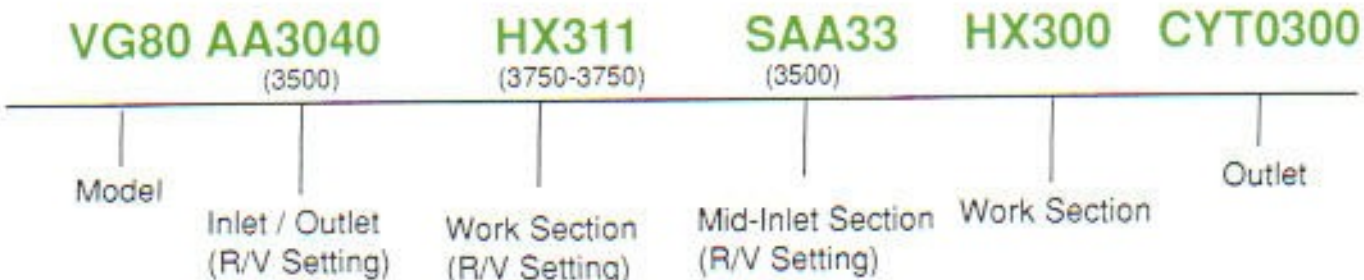

A complete part number code is developed in the following manner:

• Inlet / Outlet

This part can serve as both the inlet and outlet. It has high pressure and low pressure ports on both the side and top faces of the casting. It also has a relief valve port.

• Work Sections:

There are 4 characteristics that must be determined to develop a complete work section code.

- 1. Function**— determine circuitry (parallel or tandem) and the type of spool required (cylinder or motor)
- 2. Left or right handed valve** – determine the orientation of flow vs. the location of the spool pin-eye.
 - Left hand flows from left to right with pin-eye in front
 - Right hand flows from right to left with pin-eye in front
- 3. Porting** – Determine size and type of fitting

4. Port Accessories – Determine type of R/V (if any) and pressure settings. Both ports must be coded.

Mid-Inlets

These sections allow the flow from a second pump to be introduced into the valve bank. They can have high and low pressure ports on top.

Outlets

Outlet sections cap the valve bank. They can have all low pressure ports, high and low pressure ports (for pressure beyond circuits) or no ports at all, in which case the low pressure port in the inlet is used as an outlet.

Meter-In Performance

With Hydraulic Remote and Manual Operators

The meter-in curve show flows out of the work port vs. pilot pressure (left side of curve) and flow vs. spool stroke (right side). The open loop curve is a no-load condition while the other shows flow under a 2000 psi load.

Special metering notches in the spool result in a very small decrease in the metering range under an increase in pressure. This gives improved control to the machine operator.

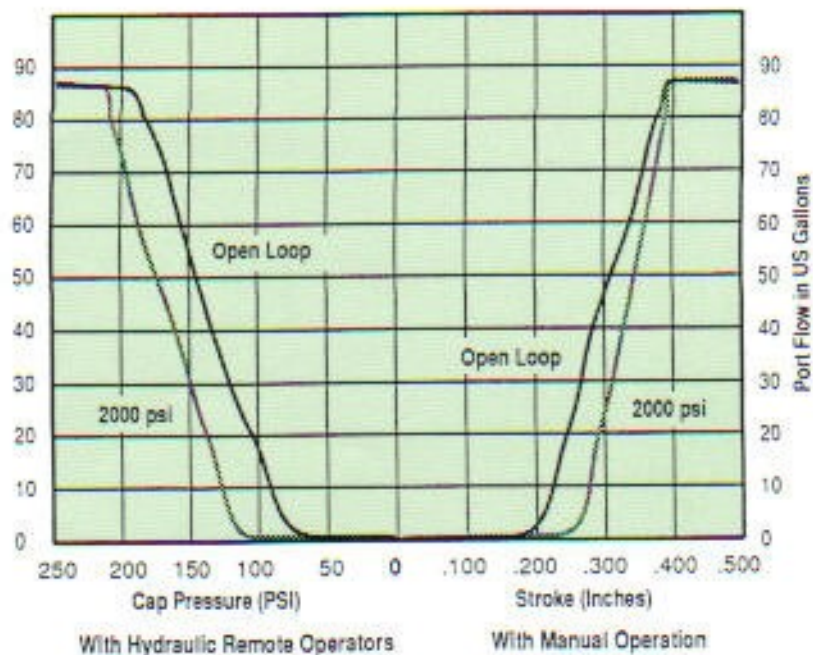

Inlet Sections

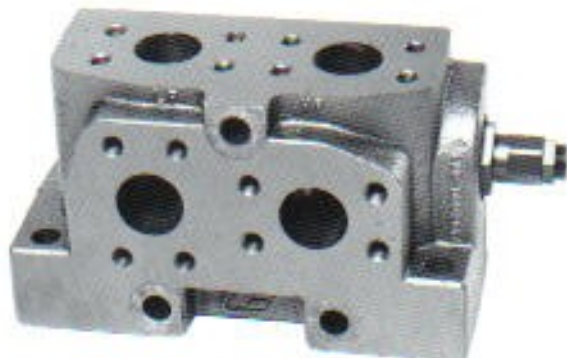

This casting can be used as a combination inlet / outlet. They offer high-and low-pressure ports on the top and on the side and contain a relief valve port. The main relief valve is pilot operated and screw adjustable. SAE straight thread or split flange fittings are available in the ports.

Sample Coding for

Inlet Section Shown **AA 4 4 4 4**

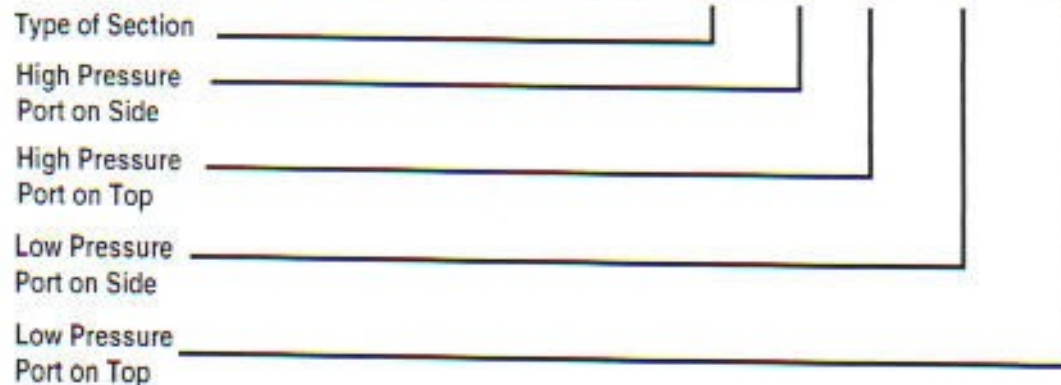

Code	Description
AA	Inlet Section With Screw Adjusted R/V
CA	Inlet With R/V Port Plugged

Code	Port Size & Type
2	1" SplitFlange
3	1 1/4" Split Flange
4	1 1/2" Split Flange
5	SAE-14
6	SAE-16
7	SAE-20
8	SAE-24
9	SAE-32
0	No Ports

Inlet Code AA

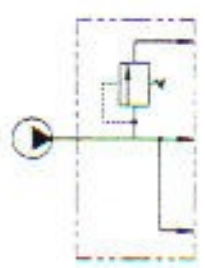

Work Sections

All work sections have accessory machining

Sample Work Section Coding..... H X 3 1 1



Function Code

H – D. A. Cylinder. Parallel. Work ports closed in neutral

L – D. A. Motor. Parallel. Work ports open in neutral

J – S.A. Cylinder (Port B) Parallel. Work port B blocked in neutral.

GT – D.A. Cylinder. Tandem with 4th position float. Work ports blocked in neutral.

Operator Code

Left hand Sec.	Right Hand Sec.
Operator @ B end	Operator @ A end
A – Spring Return	-E
B – 3-Position Detent	-F
X – Hyd Remote With Metering	-X
XP – Hyd Remote W/O Metering	-XP

Porting Code (Type & Size)

2 – 1" Split Flange

3 – 1 1/4" Split Flange

5 – SAE-14

6 – SAE-16

7 – SAE-20

8 – SAE-24

Accessory Code

Port A	Port B
1 – R/V + Anti-Cav	-1
2 – Anti-Cav	-2
5 – Plastic Closures	-5
9 – Steel Plug	-9

Pilot Pressures Required (500 psi Recommended)

Type of Section	Start Metering	End of Metering	Full Stroke	Full Stroke Into Float
DA Section Code X	50 psi	200 psi	250 psi	
DA Section Code XP	50 psi	85 psi	100 psi	
DA Float Section	50 psi	165 psi	175 psi	400 psi

VG80 D.A. parallel work section housings are symmetrical. Therefore, the spool can be inserted from either end of the bore. This allows the valve bank to be assembled for left or right hand operation.

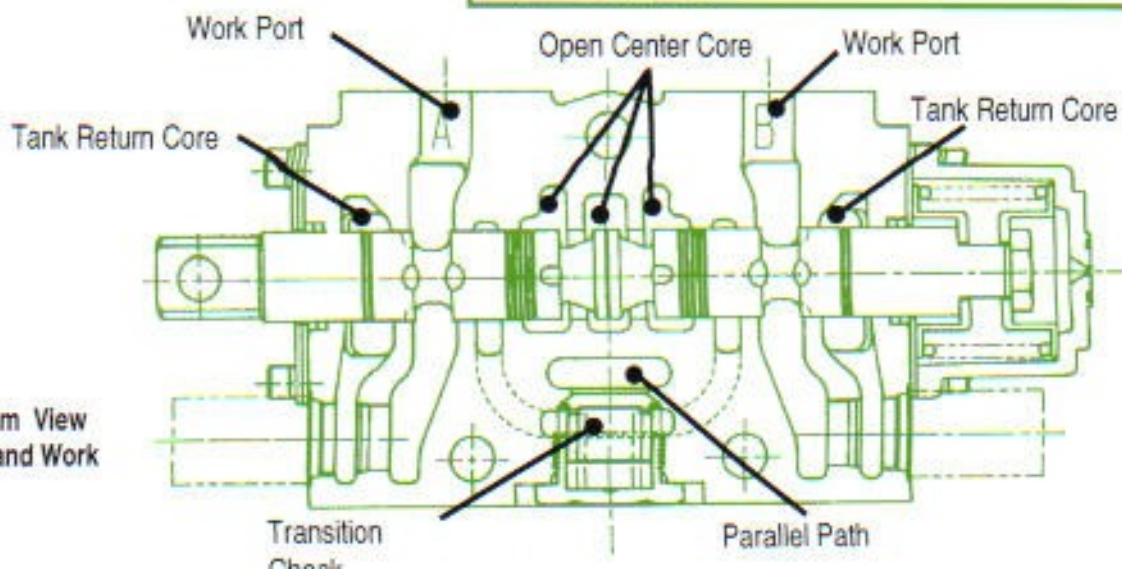
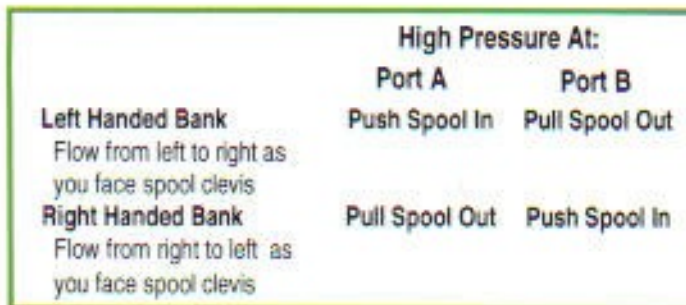

Typical Upstream View Through Left Hand Work Section

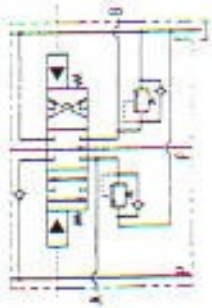

Double-Acting Cylinder
Hyd. Remote operator
Parallel Circuit

Code HX311

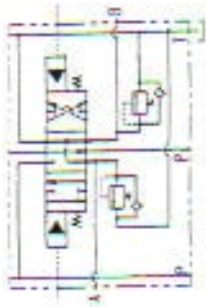

Double-Acting Motor
Hyd. Remote Operator
with Metering
Parallel Circuit

Code LX311

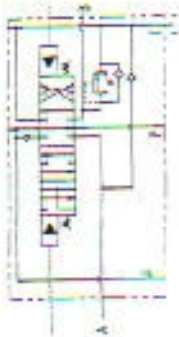

Double-Acting Cylinder
Tandem Circuit
4th Position Float
in Neutral

Code GTX300

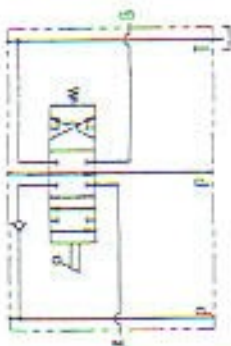

Double-Acting Cylinder
Spring Return
Parallel Circuit

Code HA322

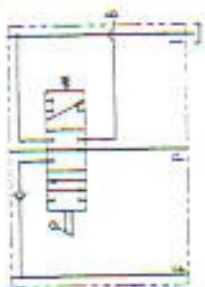

Single-Acting Cylinder
Spring Return
Parallel Circuit

Code JA300



Mid-Section Inlets

Sample Mid-Section Inlet Codes

SAS	3	3
Function	HIGH Pressure TOP	LOW Pressure TOP

Code	Description
------	-------------

- SAA – Split Flow With Screw Adjustable R/V
- SCA – Split Flow Without R/V
- CAA – Combined Flow With Screw Adjustable R/V
- CCA – Combined Flow Without R/V

Code	Port Size & Type	Code	Port Size & Type
2	1" Split Flange	5	SAE-14
3	1 1/4" Split Flange	6	SAE-16
		7	SAE-20
		8	SAE-24



Note: There is a midinlet selector type available that provides split-flow in one position and combined-flow in the other. In the combined-flow mode, flow from the second pump is directed upstream to provide two-speed operation for all of the sections. Operation of the selector can be manual or by hydraulic remote.

Inlet Code SAA

Inlet Code CAA



Outlet Sections

Sample Outlet Code

CYT	0	3	0	0
Function	LOW Pressure Port On SIDE	LOW Pressure Port On TOP	HIGH Pressure Port On SIDE	HIGH Pressure Port On TOP

Code	Description	Code	Port Size & Type
ZT	LOW Pressure, ALL Ports	2	1" Split Flange
		3	1 1/4" Split Flange
		4	1 1/2" Split Flange
CYT	Pressure Beyond, Convertible to Codes DYT or AYT	5	SAE-14
		6	SAE-16
		7	SAE-20
DYT	LOW Pressure All Ports. Convertible to Pressure Beyond by Replacing Short Plug with Long Plug	8	SAE-24
		9	SAE-32



Code CYT



Code ZT

- AYT Pressure Beyond with Screw Adjustable R/V
Convertible to DYT or CYT

Code ZT

Code CYT

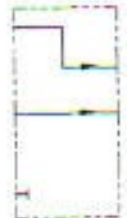

Relief Valve Performance

Main Relief Valve Curve

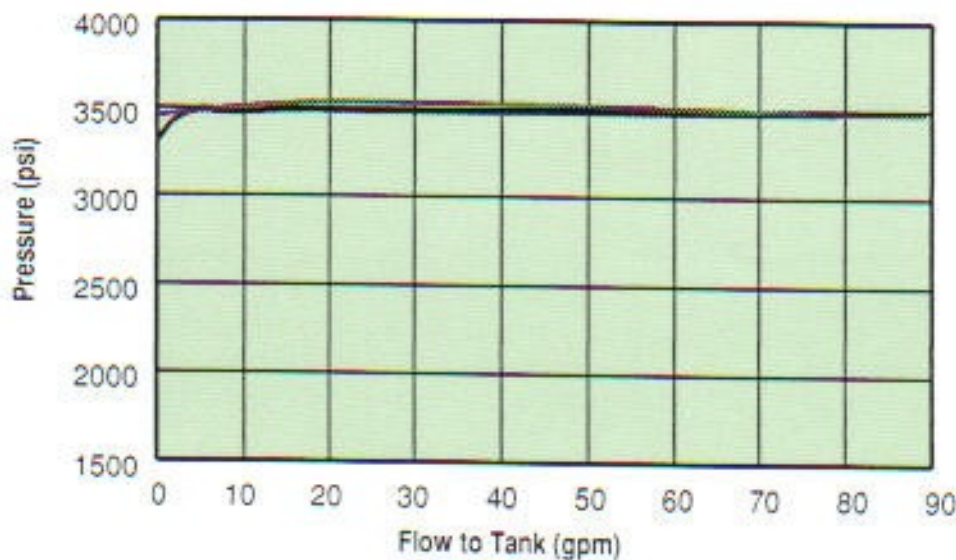

Commercial's VG80 inlets are available with the following relief valve options:

- Pilot operated, screw adjustable, main relief valve with choice of 2 pressure ranges.
 - 1000 – 2500 psi
 - 2500 – 3500 psi
- No relief valve. R/V port is plugged
- Anti-cavitation check

Port Accessory Options Include:

- Pilot operated R/V + AC screw adjustable
- Anti-cavitation check
- Lock-out R/V

Anti-Cavitation Curve

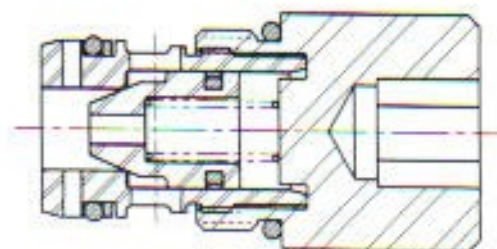
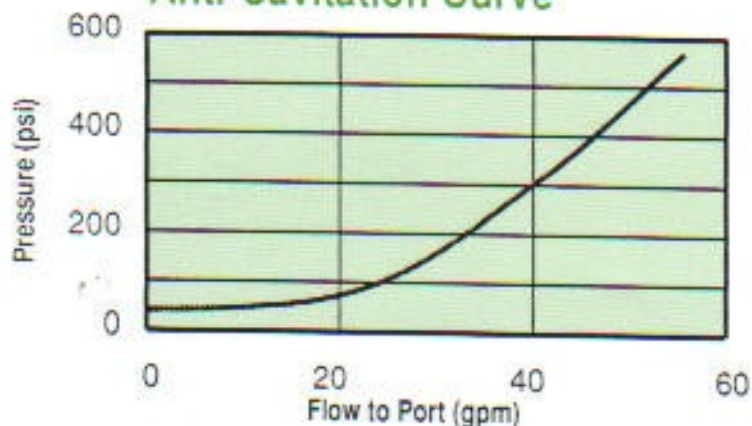

Anti-cavitation Check

Full-Flow Port Relief Valve Flow Curve

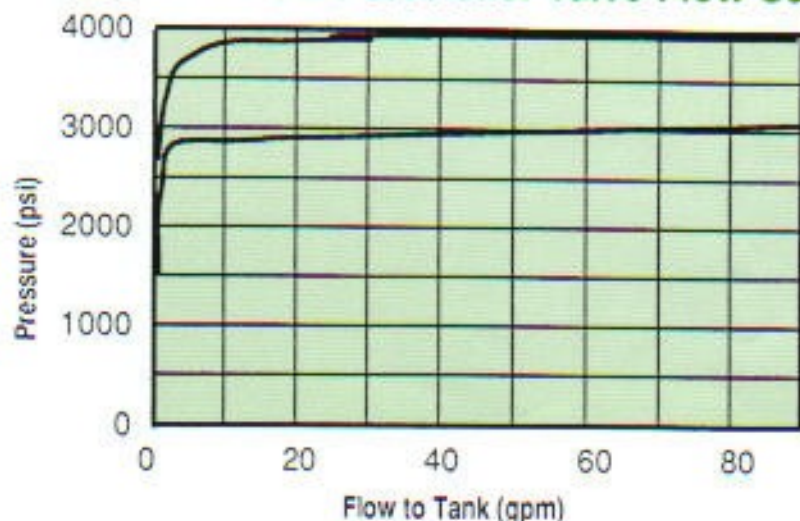

Port Relief Valve

Open Center Pressure Drop

US GPM	60	70	80	90	100	110	120	
	IGPM	58	67	75	83	92	100	
L/PM	227	265	303	341	378	416	454	
Number of Sections in Assembly	1	14	21	23	32	41	51	60
		1.0	1.4	1.6	2.2	2.8	3.5	4.1
	2	29	39	47	61	75	90	118
		2.0	2.7	3.2	4.2	5.2	6.2	8.1
	3	43	58	71	90	109	129	168
		3.0	4.0	4.9	6.2	7.5	8.9	11.6
	4	58	76	95	119	143	167	219
		4.0	5.2	6.6	8.2	9.9	11.5	15.1
	5	72	95	119	148	177	206	269
		5.0	6.6	8.2	10.2	12.2	14.2	18.6
	6	86	113	142	177	211	245	319
		5.9	7.8	9.8	12.2	14.6	16.9	22.0

Values shown in pressure drop tables are in $\frac{\text{PSI}}{\text{BAR}}$

Open Loop Pressure Drop

US GPM	60	70	80	90	100	110	120			
	IGPM	58	67	75	83	92	100			
L/PM	227	265	303	341	378	416	454			
Number of Sections in Assembly	1	Inlet to Work Port	80	108	142	174	204	236	274	100
		Work Port to Outlet	36	44	56	66	82	94	107	117
	2	Inlet to Work Port	85	114	150	184	215	250	288	108
		Work Port to Outlet	38	46	59	69	87	100	119	133
	3	Inlet to Work Port	90	120	158	194	227	264	302	117
		Work Port to Outlet	40	48	61	71	92	107	125	137
	4	Inlet to Work Port	95	131	166	204	238	277	315	125
		Work Port to Outlet	41	49	64	74	97	113	131	145
	5	Inlet to Work Port	100	131	174	214	249	291	329	133
		Work Port to Outlet	43	51	66	76	102	119	139	153
	6	Inlet to Work Port	105	137	182	224	260	305	343	141
		Work Port to Outlet	45	53	69	79	107	125	145	159

Remote Control Operators

- **Hydraulic,**
- **Electro-Hydraulic**
- **Pneumatic**

Hydraulic Remote Controllers

Commercial's joystick types and stackable hydraulic remote controllers offer precise metering and excellent performance. Our standard spring packs are specifically matched to the springs in our control valves to assure optimum metering and repeatability.

Joysticks and stackable controllers are available with electric or mechanical detents, electric switch handles or standard ball knob handles. Stackable units are also offered with a foot pedal. Both types of controllers are available in a marine version.

For more information ask for:
Oil Hydraulic Remote Control Catalog H-113
Digitrak Electronic Remote Controllers Catalog H-128

Pneumatic Remote Control Devices

Commercial offers a fine line of air operated remote devices. They require 11.7 cfm @ 100 psi. These controllers are available in dual types that operate one valve spool and quad models that control two spools. Detents are available in dual (stackable) models only. Ask for Catalog H-111VA for full details

 **Commercial Intertech**

Hydraulic Valve Div.
373 Meuse Argonne
Hicksville, OH 43526-6611
Phone (419) 542-6611 • Fax (419) 542-8871



Commercial Intertech

Global Headquarters are located at 1775 Logan Avenue, Youngstown, Ohio 44501-0239 • U.S.A.

...we're putting technology to work worldwide

District sales offices:

ACTON, ON L7J 2M6 CANADA

Commercial Intertech Ltd.
294 Queen St. East, Suite C
P.O. Box 450
Phone: (519) 853-0770
Facsimile: (519) 853-3837

BEAVERTON, OR 97005-5464

6700 S.W. 105th, Suite 311R
Phone: (503) 643-0195
Facsimile: (503) 641-4360

BENTON, AR 72018-0647

20138 I-30
P.O. Box 647
Phone: (501) 794-0334
Facsimile: (501) 794-0732

CHICAGO, IL 60638-4911

6501 West 65th Street
Phone: (708) 594-1161
Facsimile: (708) 458-2463

DALLAS, TX 75234-7311

2655 Villa Creek Drive, Suite 299
Phone: (214) 241-1975
Facsimile: (214) 241-2128

HICKSVILLE, OH 43526

373 Meuse Argonne
Phone: (419) 542-6611
Facsimile: (419) 542-8871

KINGS MOUNTAIN, NC 28086-0219

101 Canterbury Road
P.O. Box 219
Phone: (704) 739-8232
Facsimile: (704) 739-2269

ORANGE, CA 92667-5597

341 West Collins Avenue
Phone: (714) 639-4630
Facsimile: (714) 532-4126

YOUNGSTOWN, OH 44501-0239

1775 Logan Avenue
P.O. Box 239
Phone: (216) 746-8011 • Telex: 433-2153
Facsimile: (214) 746-1148

Subsidiary companies:

MINNEAPOLIS, MN 55428-4998

Oildyne Division
Commercial Intertech Corp.
4301 Quebec Avenue, North
Phone: (612) 533-1600
Facsimile: (612) 533-0082

MINNEAPOLIS, MN 55434

Cylinder City, Inc.
1532 93rd Lane, N.E.
P.O. Box 34220
Phone: (612) 780-2550
Facsimile: (612) 780-2565

**PORT MELBOURNE, VICTORIA 3207,
AUSTRALIA**

Commercial Hydraulics Pty., Ltd.
265 Ingles Street, P.O. Box 191
Phone: 61-3-646-2017 • Telex: 34377
Facsimile: 61-3-646-2257

SAO PAULO, BRAZIL

Commercial Intertech do Brasil Ltda.
Rua AMF do Brazil, 251
18120 - Mairinque
Sao Paulo, Brazil
Phone: 55-11-428-2122
Facsimile: 55-11-428-2099

GLOUCESTER GL3 4XE, ENGLAND

Commercial Hydraulics Gloucester Ltd.
Gloucester Trading Estate, Hucclecote
Phone: 44-452-618-666
Telex: 43651 CHCLOS G
Facsimile: 44-452-371-106

GRANTHAM NG31 9SJ, ENGLAND

Commercial Hydraulics Kontak Ltd.
Belton Park, Loundonthorpe Rd.
Grantham, Lincolnshire
Phone: 44-476-64105
Facsimile: 44-476-66462 Telex: 37170

LIVERPOOL L9 7BW, ENGLAND

Commercial Hydraulics Liverpool Ltd.
Long Lane, Fazakerley
Phone: 44-51-525-5933
Telex: 629-561 COMLIV G
Facsimile: 44-51-523-4198

WARWICK CV34 6TU, ENGLAND

Commercial Hydraulics Keelavite Ltd.
Tachbrook Park Drive, Tachbrook Park
Phone: 0926-889-000
Facsimile: 0926-889-172

FRANCE

Commercial Hydraulics Astron S.A.R.L.
BP 73,
20, rue Pierre Mendès - France, Torcy
77202 Marne La Vallée - Cedex 01
Phone: 33-1-6462-1100
Telex: 693-737 F
Facsimile: 33-1-6462-1093

LAMADELAINE, LUXEMBOURG

Commercial Intertech S.A.
39, rue de la Gare, L-4873
Phone: 352-503-7271
Telex: 848-3367
Facsimile: 352-501-359

STOCKHOLM, SWEDEN

Commercial Hydraulics AB
Veddestavagen 24, S-175-62 JARFALLA
Phone: 46-8-795-5660
Facsimile: 46-8-795-6621

VERONA, ITALY

Commercial Hydraulics SRI
Via dell'Agricoltura 1/A
Phone: 39-45-676-7250
Telex: 843-351-893
Facsimile: 39-045-676-7229