

# TORQUE-HUB<sup>®</sup>

## Final Drives

### ASSEMBLY-DISASSEMBLY MANUAL

FOR THE



UNIT

**FAIRFIELD**

*THE FORCE BEHIND THE FUTURE*

# Introduction

---

This Service Manual is a step-by-step guide designed for the customer or shop mechanic who is servicing or repairing a particular model of Torque-Hub Final Drive. (The model covered by this copy of the Manual is specified on the Manual cover.)

Included are —

1. assembly and exploded view drawings
2. disassembly procedure
3. main assembly procedure (assuming all sub-assemblies to be intact)
4. sub-assembly procedures.

At the time of printing, this Manual was complete for the specific Torque-Hub model designated. However, Fairfield Manufacturing Co., Inc., reserves the right to update and improve its products at any time. All specifications and procedures are therefore subject to change without notice.

---

## Safety

Standard safety practices should be followed during the disassembly and assembly procedures described. Safety glasses and safety shoes should be worn; heavy, heat resistant gloves should be used when heated components are handled. Be especially alert when you see a caution symbol () . This symbol indicates that a particular operation could cause personal injury if not performed properly or if certain safety procedures are not followed.

# S3A-A Drive Disassembly Procedure

---

1. Loosen all 12 Cover Bolts [4 Shoulder Bolts (18), 8 Grade 8 (17)] and drain the oil from the unit.

2. Remove the 12 Cover Bolts and Lift off the Cover (6). Discard the 'O' Ring Seal (5) from the Cover (6) counterbore.

Remove Thrust Washer (8) from Counterbore of the inside face of the Cover (6).

3. Lift out the Carrier Sub-Assembly (3A) and \*Thrust Bearing Set (15 & 16). A Thrust Washer may stick inside the Cover (6).

4. Pry or tap the Ring Gear (4) loose and remove it. Discard the 'O' Ring Seal (5) from the Hub (1G) counterbore.

5. Remove the Input Gear (13).

6. Lift out the Internal Gear (2) and \*Thrust Bearing Set (15 & 16). A Thrust Washer may stick to the bottom of the Carrier (3A).

7. Remove the Retaining Ring (1I) from the Output Shaft (1A) and discard; Remove Bearing Shim (1H) from the Output Shaft (1A).

 Eye Protection should be worn during Retaining Ring removal.

8. The Output Shaft (1A) may now be pressed out of the Hub (1G).

9. The Bearing Cups (1C) & (1E) will remain in Hub (1G) as will Bearing Cone (1F). Bearing Cone (1D) will remain on the Output Shaft (1A). Seal (1B) will be automatically removed during this procedure.

Note: If bearing replacement is necessary, the Bearing Cups (1C & 1E) can be removed with a "slide hammer puller" or driven out with a munch

10. To remove the Cluster Gear (3F) from the Carrier (3A) drive the anti-Roll Pin (3G) into the Planet Shaft (3E). The Planet Shaft (3E) can now be tapped out of the Carrier (3A) and Cluster Gear (3F). After the Planet Shaft (3E) is removed, the Roll Pin (3G) should be driven out of the Planet Shaft (3E). The Cluster Gear (3F) can now be removed from the Carrier (3A) along with the Thrust Washers (3B). After separating the Thrust Washers (3B) from the ends of the Cluster Gear (3F), the Needle Rollers (3C) and Spacer (3D) can be removed from the Cluster Gear (3F) bore.

WARNING: When rebuilding the unit, the 'O' Rings and Retaining Rings should always be replaced.

# Main Assembly Procedure

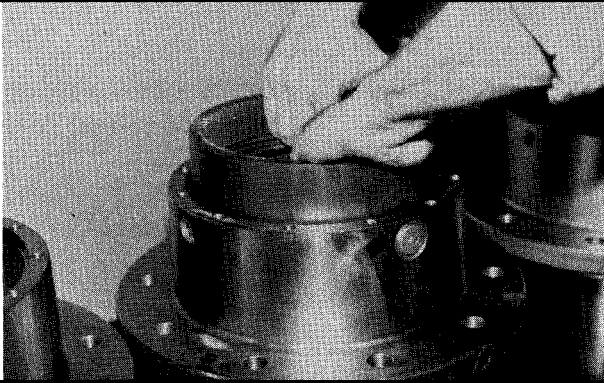

1. With the Hub Shaft Sub-assembly resting on the Shaft (1A) install Internal Gear (2). The Spline of the Internal Gear (2) bore will mesh with the Spline of the Output Shaft (1A).

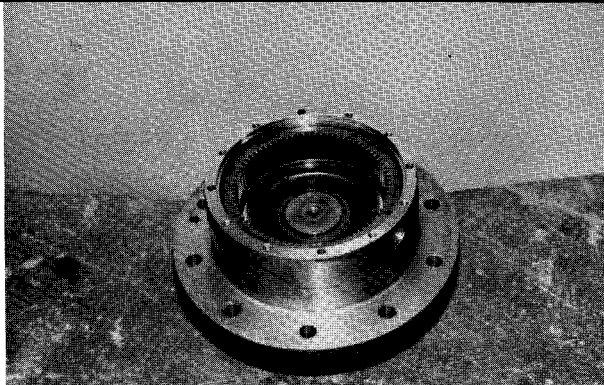

2. Inspect the location of the Internal Gear (2) on the Output Shaft (1A). The portion of the Output Shaft (1A) which does not have full Spline should protrude through the Internal Gear (2) bore.

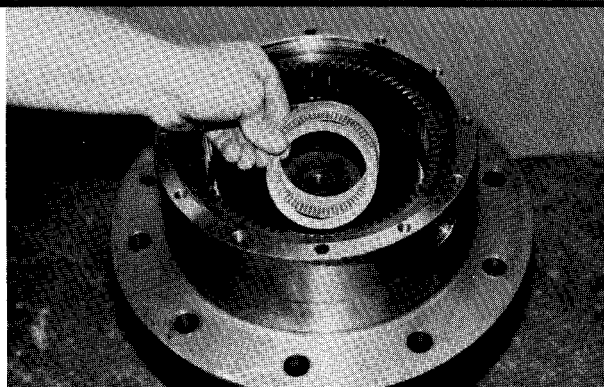

3. The 2 Thrust Washers (15) and 1 Thrust Bearing (16) are installed on that portion of Output Shaft (1A) which protrudes through Internal Gear (2).

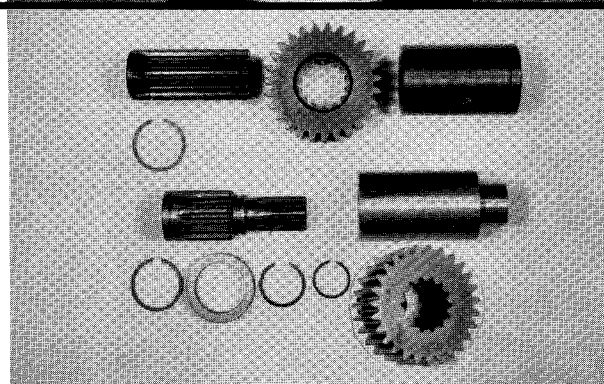

4. Pictured are the two types of "A" drive Input assemblies. The top which is used in this Manual consists of the Input Shaft (11) Retaining Ring (10) Input Gear (13) & Coupling (9). NOTE: the counter-bore of the Input Gear UP as shown with top assembly and DOWN as shown in bottom assembly. Input Shaft (11) Retaining Ring (10) Spacer (12) Input Gear (13) Retaining Ring (7) Retaining Ring (14) & Coupling (9). These Inputs are assembled the stated in this procedure.

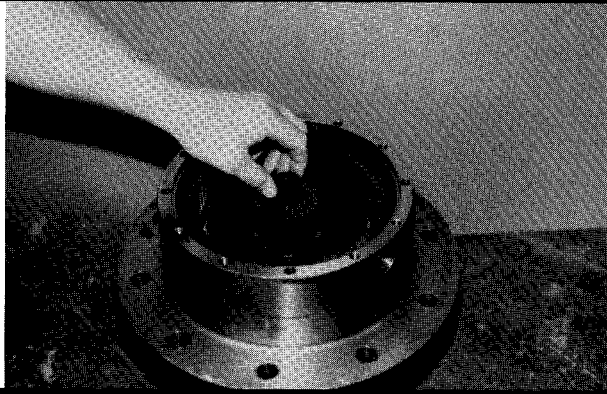

5. The Input Gear (13) is now located and centered large diameter down on the internal end of Output Shaft (1A).

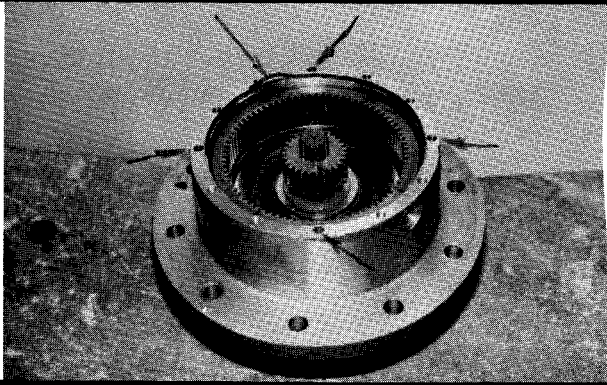

6. Place "O" Ring (5) into Hub (1G) counterbore. Use grease or petroleum jelly to hold "O" Ring in place.

 Beware of sharp edges of the counterbore while seating this "O" Ring (5).

Also at this time locate the mark the 4 counterreamed holes in the face of the Hub (1G). This is for identification later in the assembly.

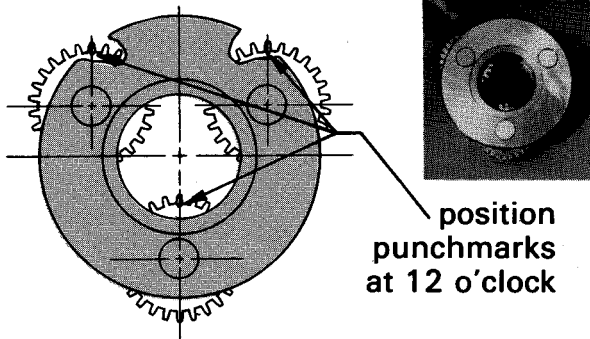

position  
punchmarks  
at 12 o'clock

7. Place Carrier Assembly on a flat surface with the large gears up and positioned as shown. Find the punch marked tooth on each large gear and locate at 12 o'clock (straight-up) from each planet pin. Marked tooth will be located just under the Carrier on upper two gears.



8. With large shoulder side of Ring Gear (4) facing down, place Ring Gear (4) over (into mesh with) large gears. Be sure that punch marks remain in correct location during Ring Gear (4) installation. The side of the Ring Gear (4) with an "X" stamped on it should be up.



9. While holding Ring Gear (4) and Cluster Gears (3F) in mesh, place small side of Cluster Gears (3F) into mesh with the Internal Gear (2) and Input Gear (13). On the Ring Gear (4) locate the hole marked "X" over one of the marked counterbored holes (Step 6) in Hub (1G).

Note: If gears do not mesh easily or Carrier Assembly does not rotate freely, then remove the Carrier and Ring Gear and check the Cluster Gear timing.



10. Another Thrust Washer (15)/Thrust Bearing (16) set is now installed into the counterbore in the face of the carrier. Use grease or Petroleum jelly to hold in place.

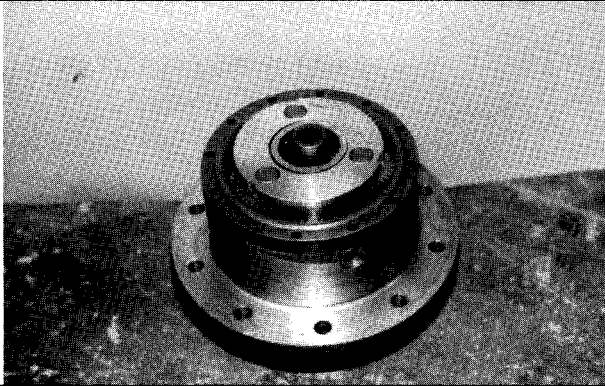

11. Coupling (9) is installed into this assembly. The spline of the Coupling (9) will align with the spline of the Input Shaft (11).

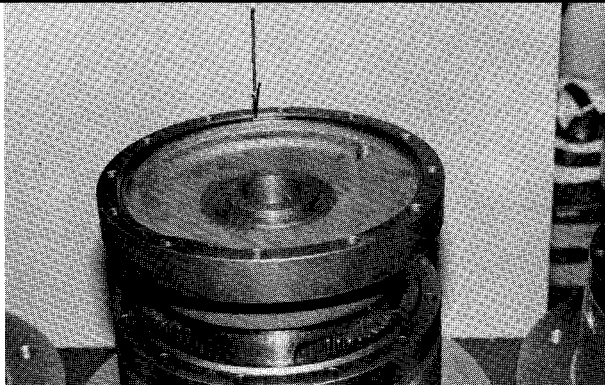

12. Place "O" Ring (5) into Cover (6) counterbore. Use grease or petroleum jelly to hold "O" Ring in place.

⚠ Beware of sharp edges of the counterbore while seating this "O" Ring.

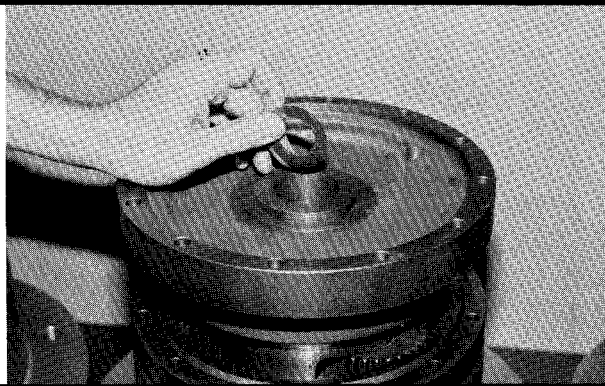

13. Using sufficient grease or Petroleum jelly to hold in place, install Thrust Washer (8) into the counterbore of the interface of the Cover (6).



14. The Cover (6) is now installed. Taking care to correctly align Pipe Plug Hole (20) with those in the Hub (1J), usually 90° to one another.

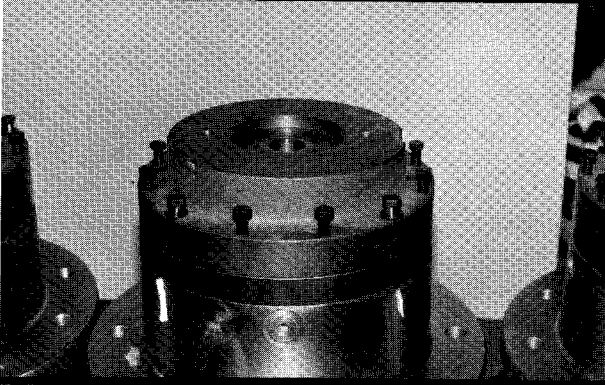

15. Locate the 4 counterbored holes in Hub (1G) [marked in Step 6] and install 4 Shoulder Bolts (18) with Lockwashers (19). A slight tap with a hammer may be necessary to align Shoulder Bolt with Hub (1G) counterbore. The remaining Grade 8 Bolts (17) with Lockwashers (19) are also installed at this time.

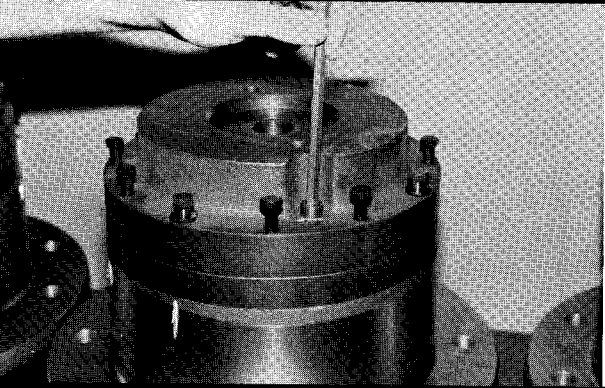

16. Pipe Plugs (20) are to be installed into Cover (6) using a lubricant seal of some sort.

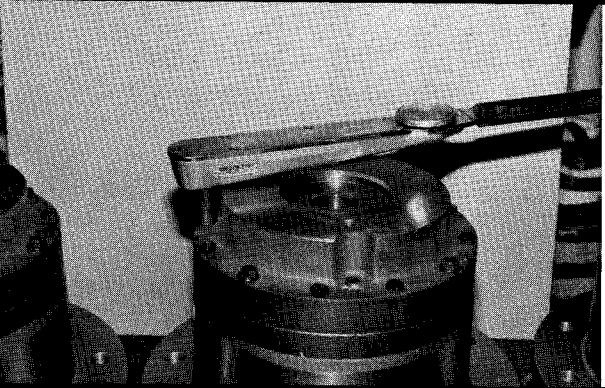

17. Torque Shoulder Bolts (18) to 43-47 ft.-lbs. and regular Grade 8 Bolts (17) to 43-47 ft.-lbs.

This completes the assembly. The unit must be filled one-half full of EP 90 lubricant before operation if the unit is mounted horizontally and completely filled if mounted vertically. In vertical mounting application circulation of the oil is recommended.

# Hub Shaft Sub-Assembly

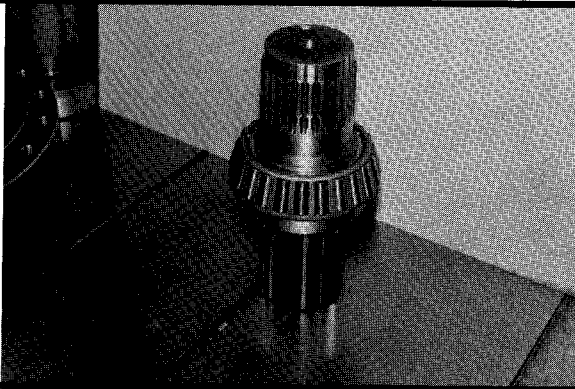

1. Press Bearing Cone (1D) onto Shaft (1A).

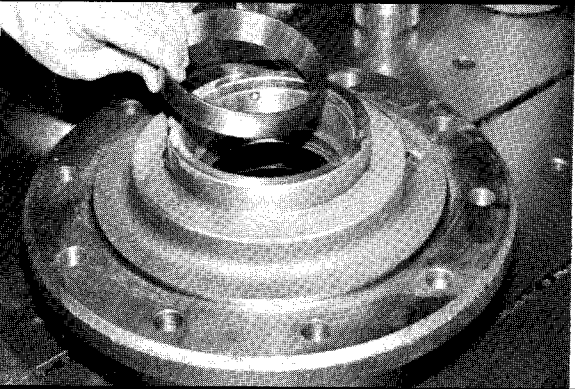

2. Press Bearing Cup (1C) into Hub (1G) taking care to insure cup start square with the bore of Hub (1G).

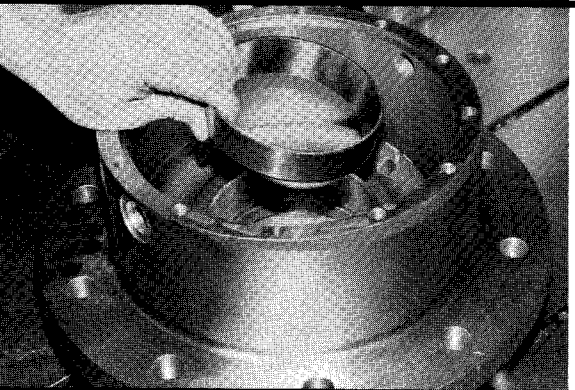

3. Invert Hub (1G) and press Bearing Cup (1E) into intercounterbore of Hub (1G).

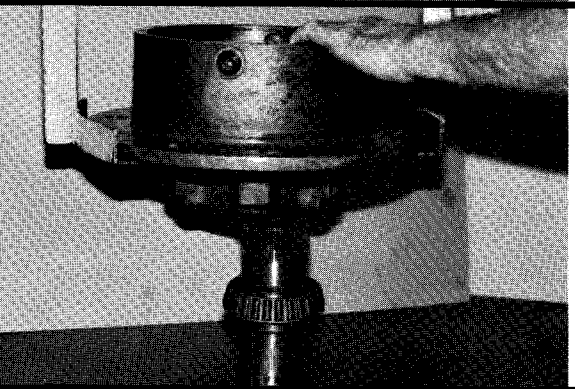

4. The Hub (1G) is now carefully lowered on to the output shaft (1A).





5. Bearing Cone (1F) is started on to the Output Shaft (1A).

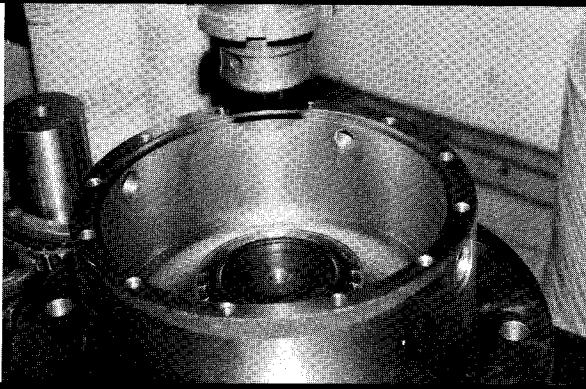

6. The Bearing Cone (1F) is an interference fit and has to be pressed or tapped on.



7. Pipe Plugs (1J & 1K) should be checked and/or installed using a lubricant seal.

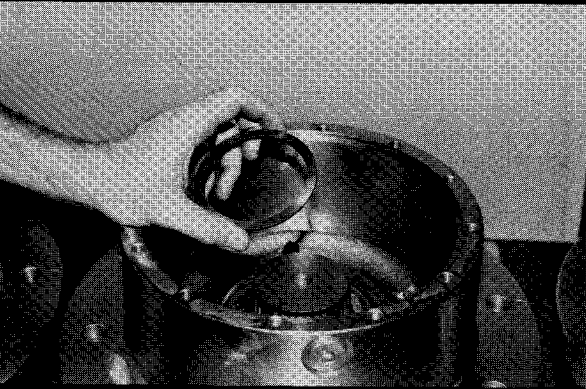

8. Bearing Spacer (1H) is installed around the Output Shaft (1A) and locates on Bearing Cone (1F).

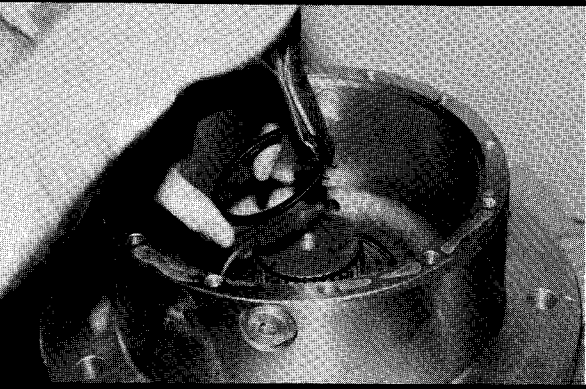

9. Retaining Ring (1I) installed into the groove provided in the Output Shaft (1A). This Retaining Ring (1I) should never be reused in a repair or rebuild.

⚠ Eye protection should be worn during this procedure.

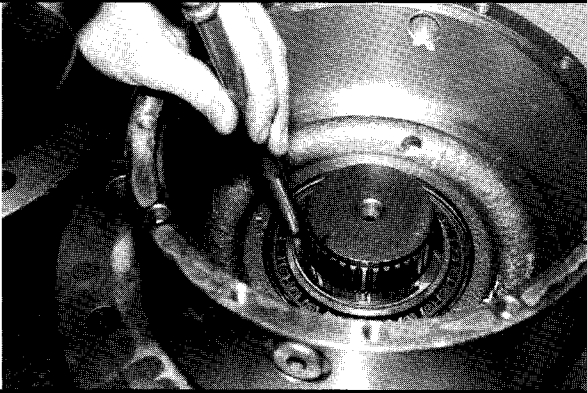

10. A soft metal punch should be used to insure that this Retaining Ring (1I) is completely seated in the groove of the Output Shaft (1A).

⚠ Eye protection should be worn during this procedure.



11. Upon completion of Step 10, rap the internal end of the Output Shaft (1A) twice with a piece of soft metal rod. This will release any preload which was on the Bearings.



12. Invert Hub (1G) and locate it on the large diameter in preparation of installing the Seal (1B). Care should be taken to insure Seal (1B) is being correctly installed (smooth face up).

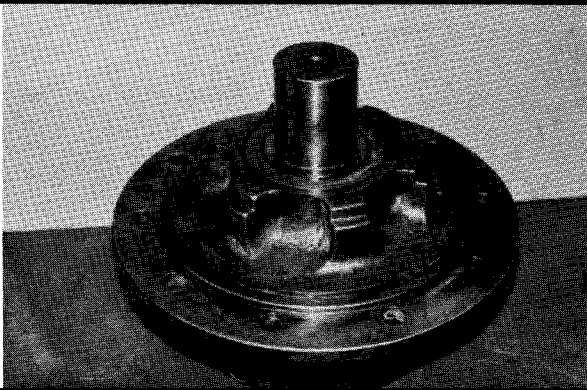

13. The Seal (1B) is to be pressed or tapped into the counterbore of Hub (1G) to the point where it becomes flush with the Hub (1G) face.

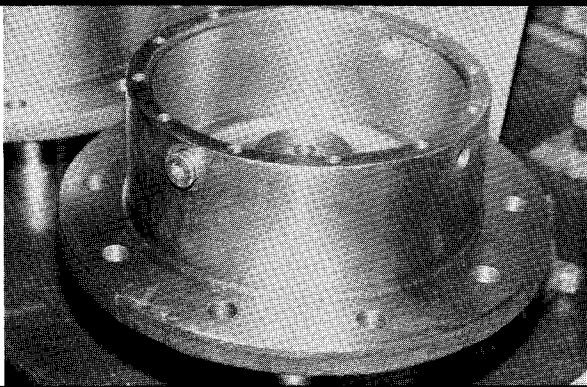

14. This completes the Hub Shaft sub-assembly — items (1A) through (1K.) If it is not going to be used immediately, it should be oiled and covered to help prevent rusting.

---

## Carrier Sub-Assembly

---

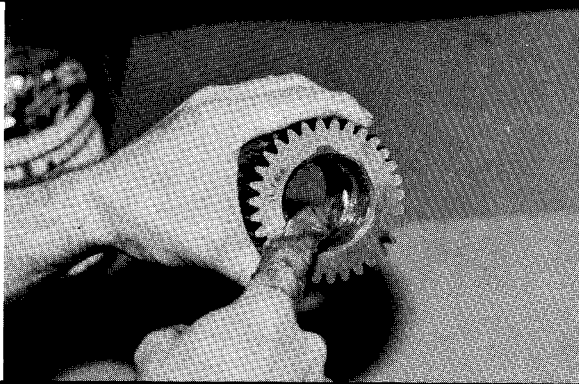

1. Apply a coat of grease or petroleum jelly to Cluster Gear (3F) bore.

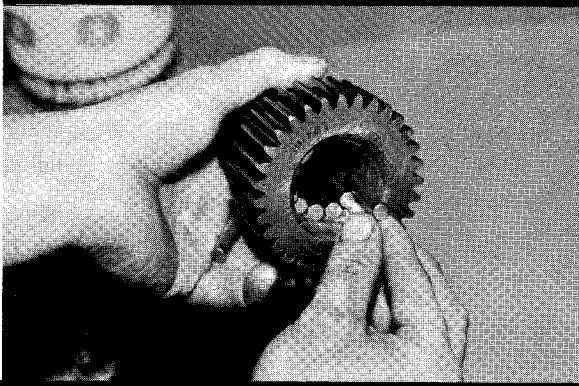

2. Place fourteen Needle Rollers (3C) into Cluster Gear (3F) bore.

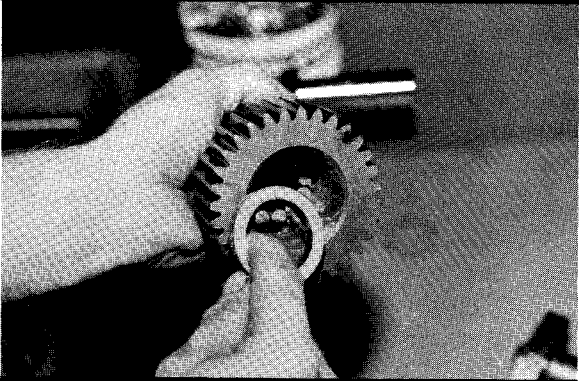

3. Place Spacer washer (3D) into opposite side of Cluster Gear (3F) and against Needle Rollers (3C).

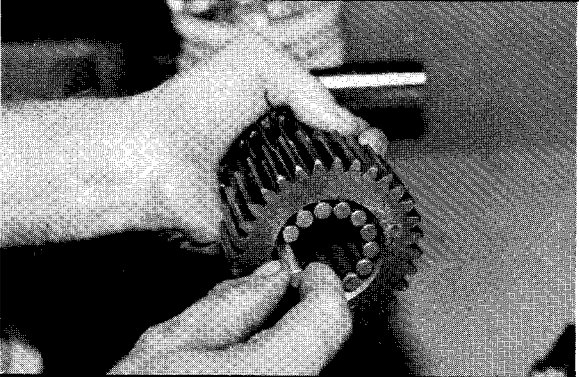

4. Place second set of fourteen Needle Rollers (3C) into Cluster Gear (3F).
-

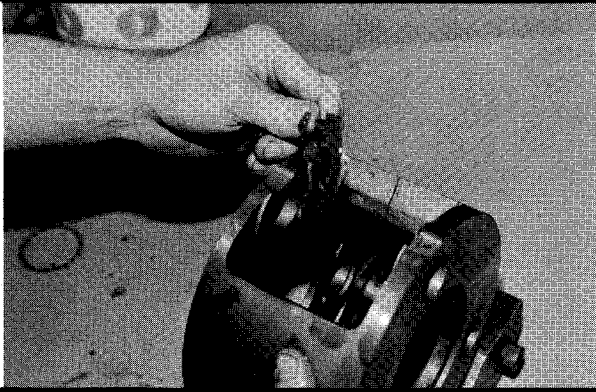

5. Apply grease or petroleum jelly to the tang side of two Thrust Washers (3B). Place Thrust Washers (3B) against bosses in Carrier (3A) with washer tang fitting into slot in Carrier outside diameter.

Note: Some old style Carriers will not have slots and tangs should be located inside boss relief.

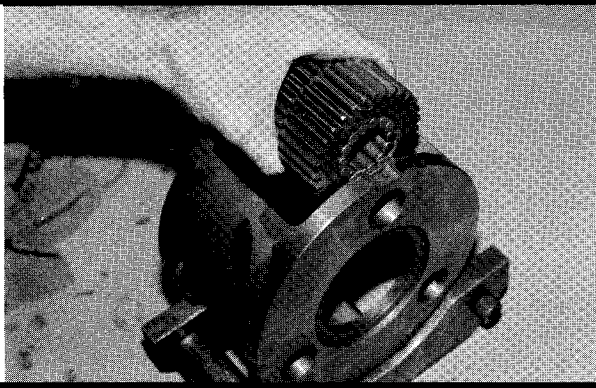

6. While keeping Thrust Washers (3B) in place, slide Cluster Gear (3F) into Carrier (3A) with the larger gear on the side with the small pin hole.

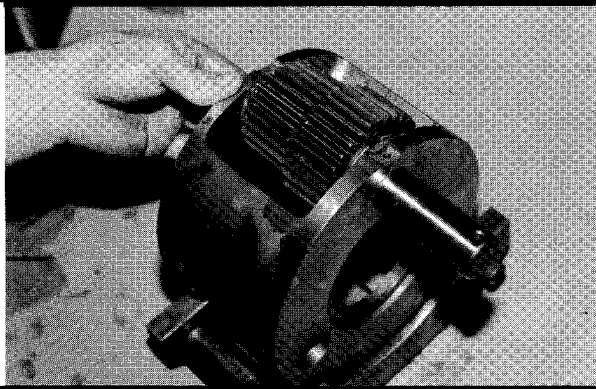

7. Line up Cluster Gear (3F) and thrust Washers (3B) with hole in Carrier (3A) and slide Planet Shaft (3E) through. Line up chamfered side of hole in Planet Shaft (3E) with pin hole in Carrier (3A).

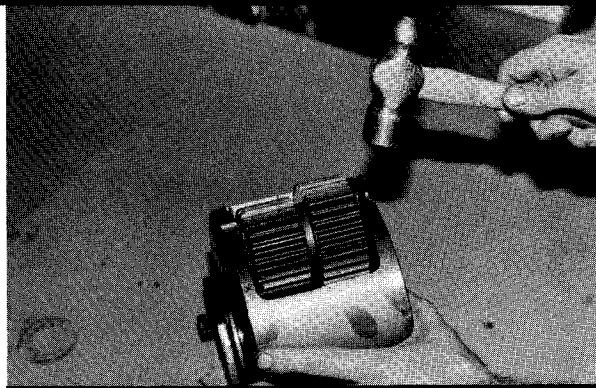

8. Drive Anti-Roll Pin (3G) flush into Carrier (3A) hole, thereby locking Planet Shaft (3E) into place.

Repeat these steps for remaining two Cluster Gears to complete Carrier Sub Assembly.

 Eye protection is to be worn during this operation.

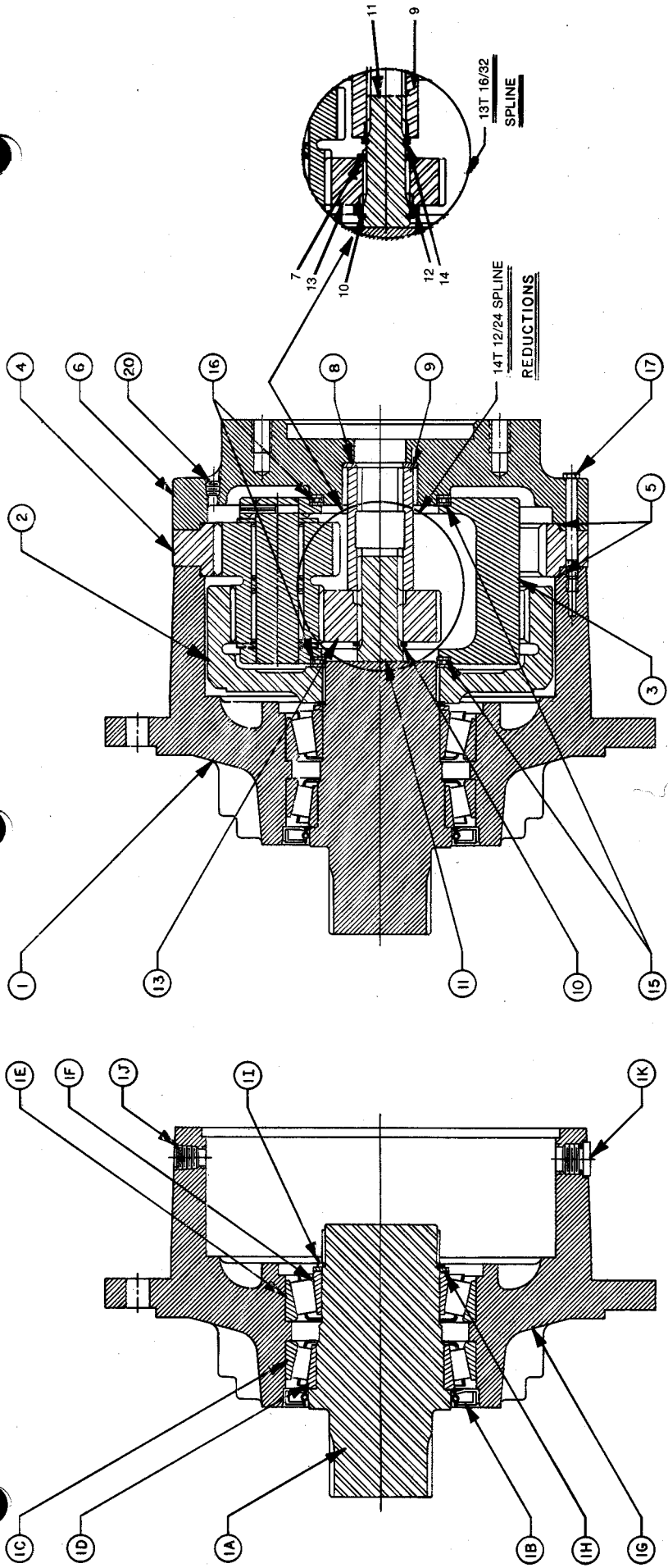

COMPLETE ASSEMBLY

HUB-SHAFT SUBASSEMBLY

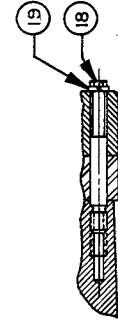

VIEW OF SHOULDER BOLT

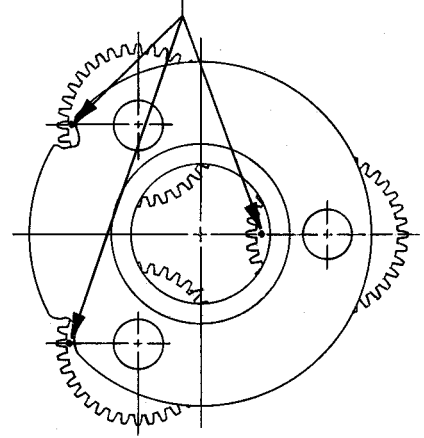

CARRIER SUBASSEMBLY